

Dot to Dot

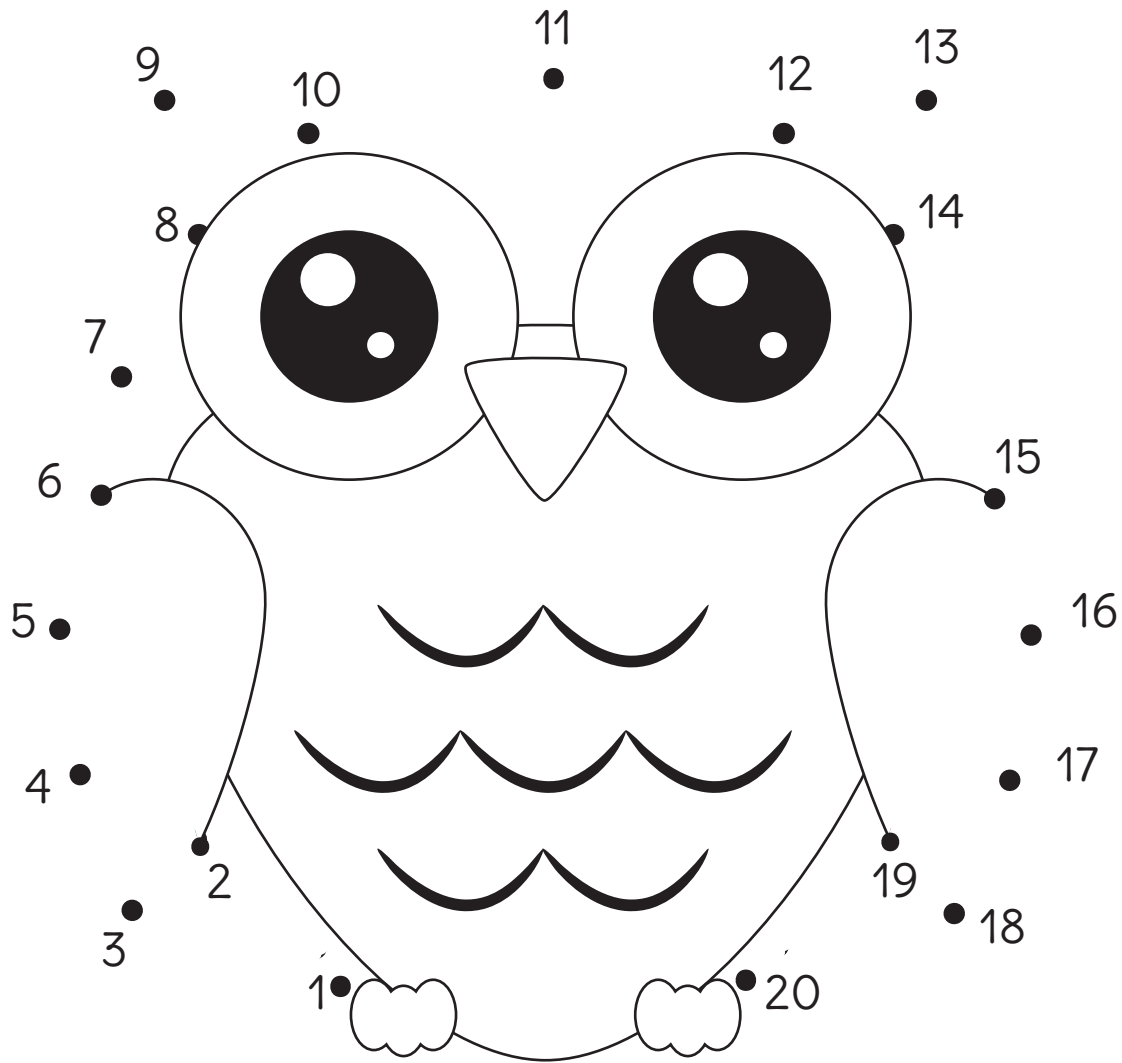

Dot to Dot

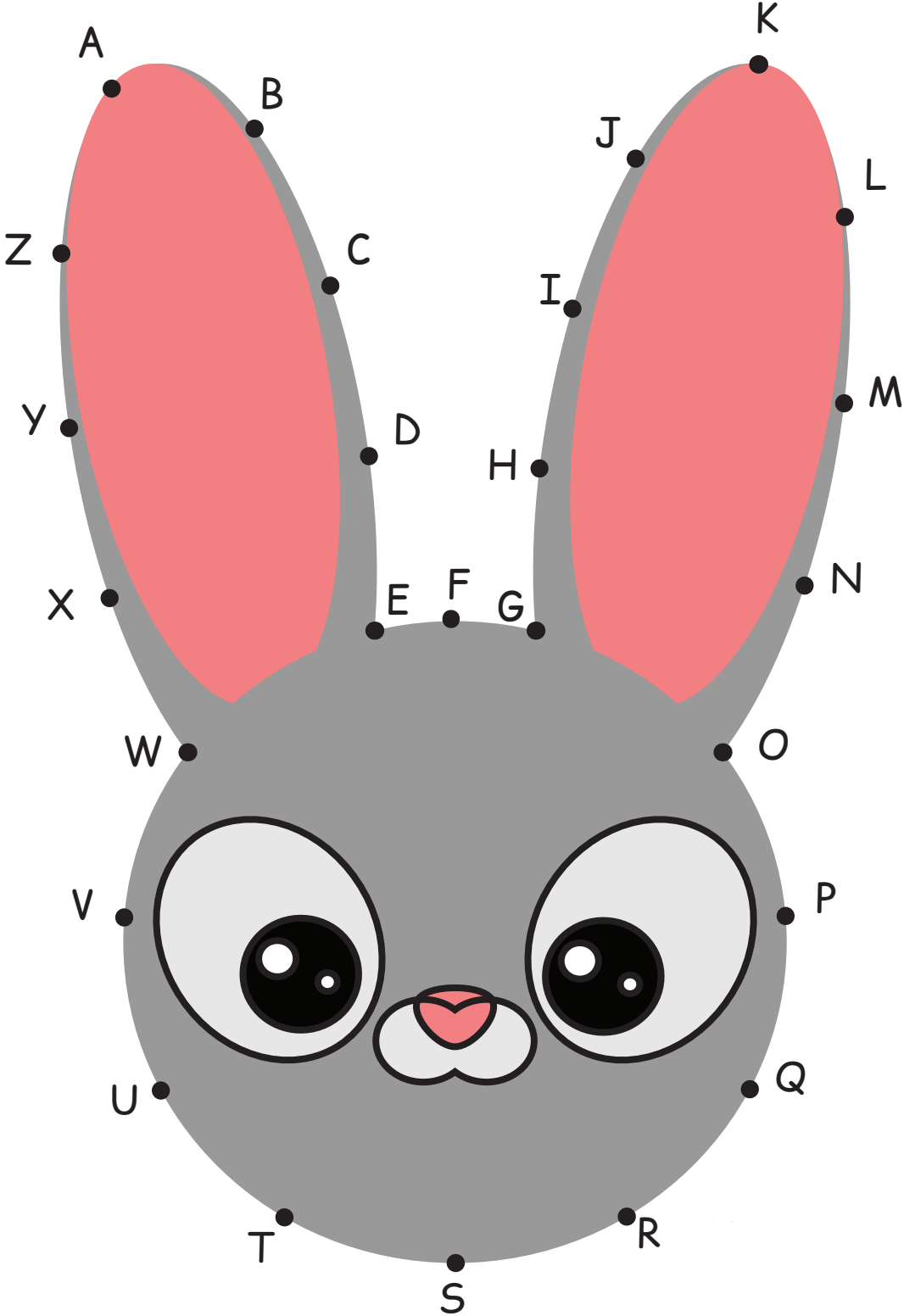

Dot to Dot

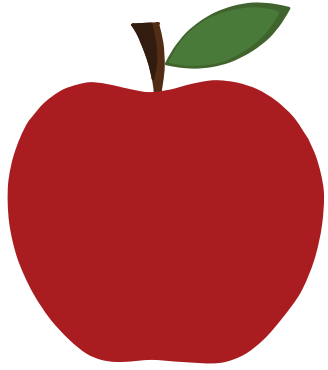
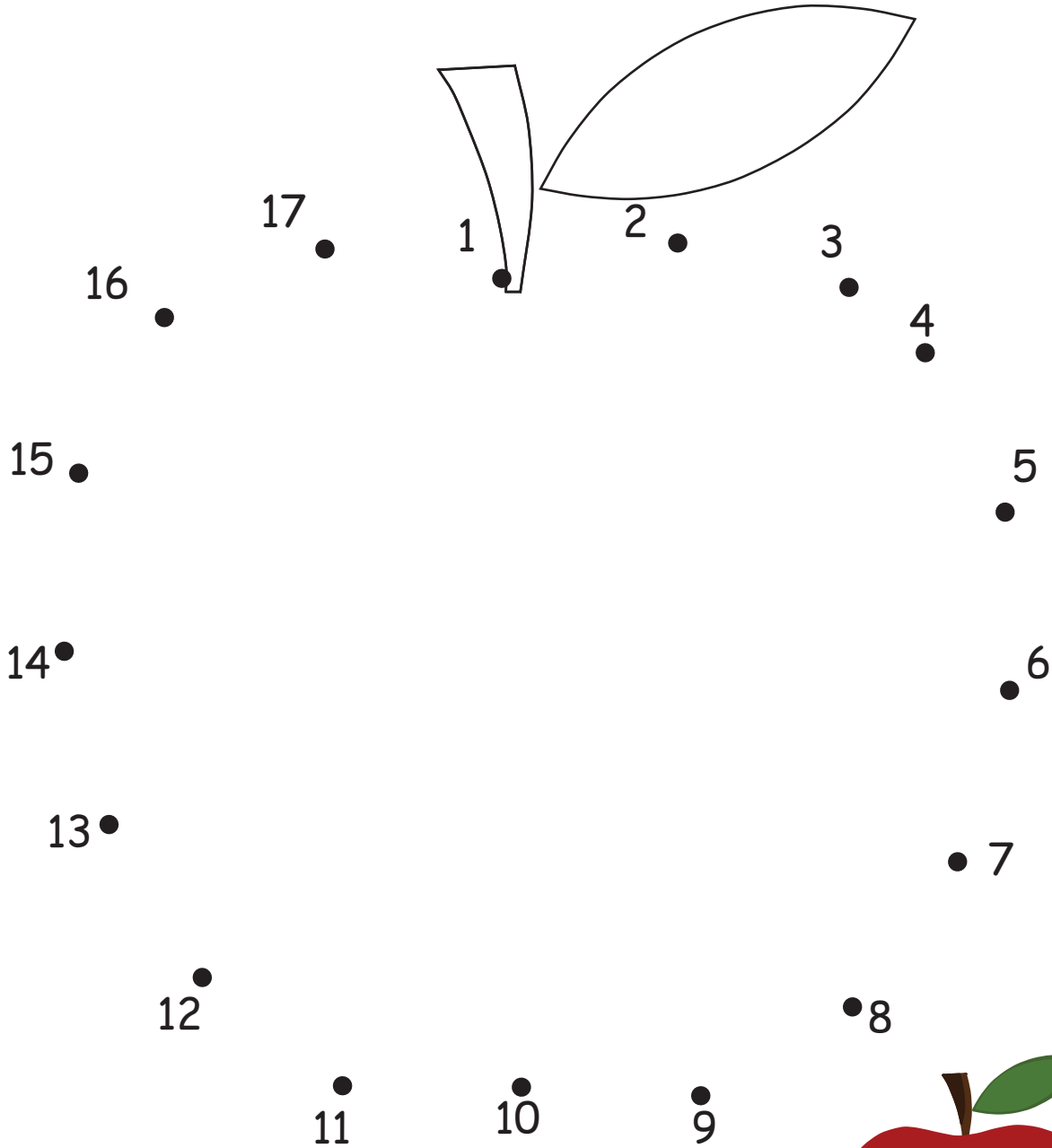

Dot to Dot

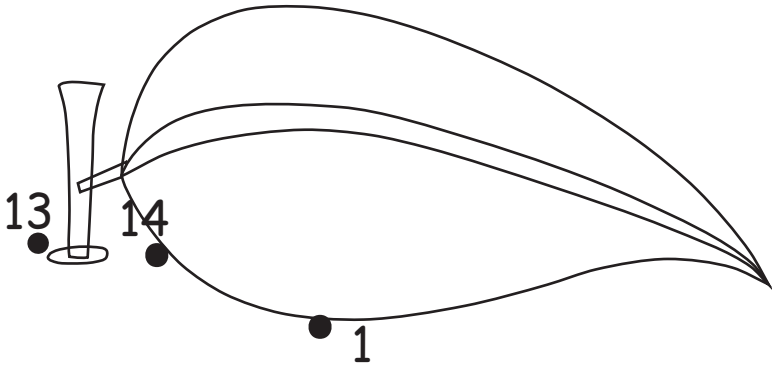

- 12 ●
- 11 ●
- 10 ●
- 9 ●
- 8 ●
- 7 ●
- 6 ●
- 5 ●
- 4 ●
- 3 ●
- 2 ●
- 1 ●

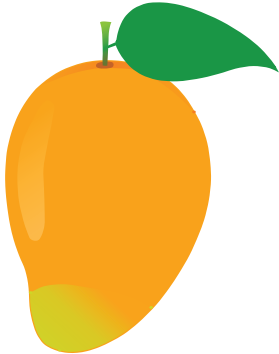

Dot to Dot

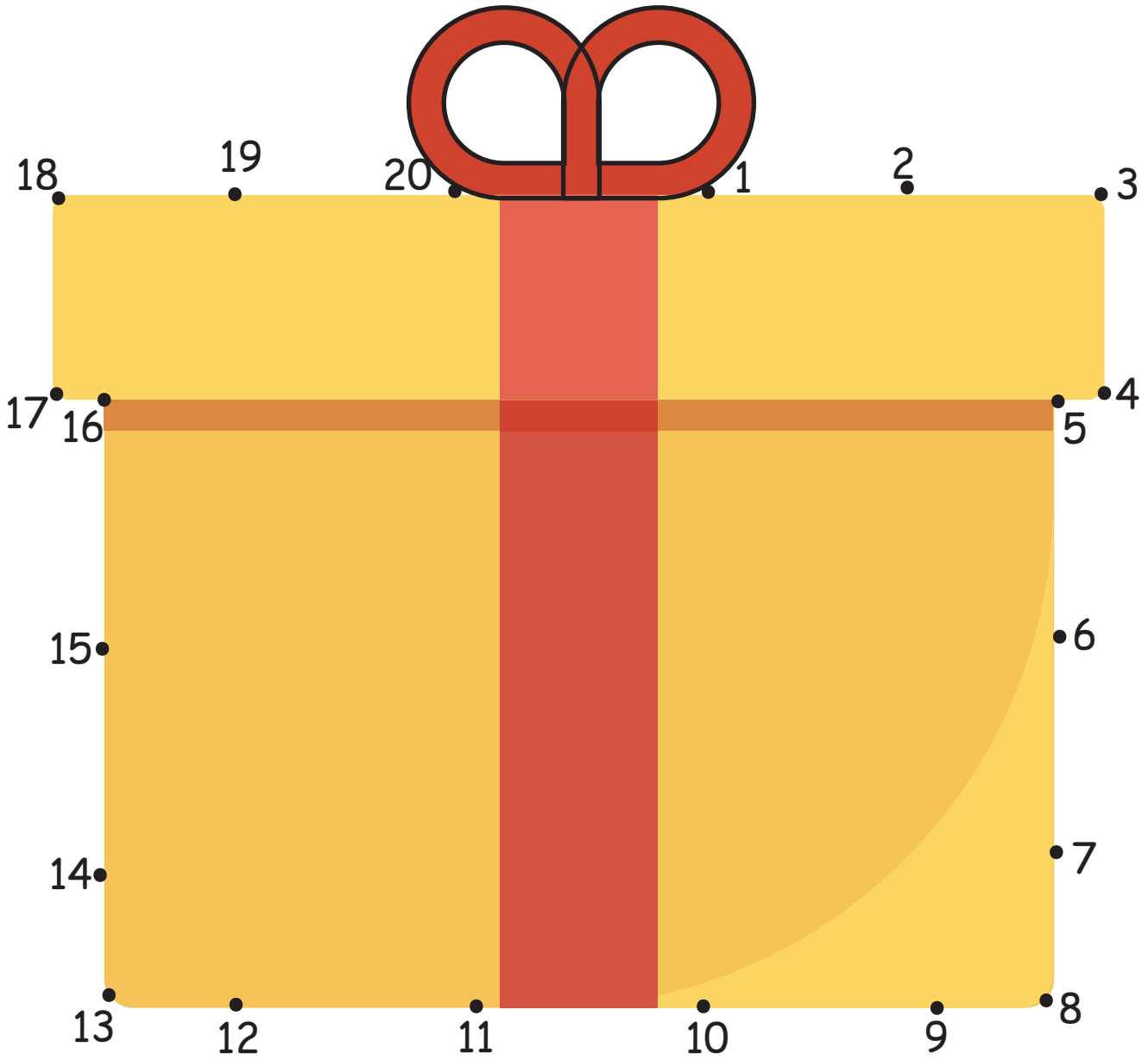

Dot to Dot

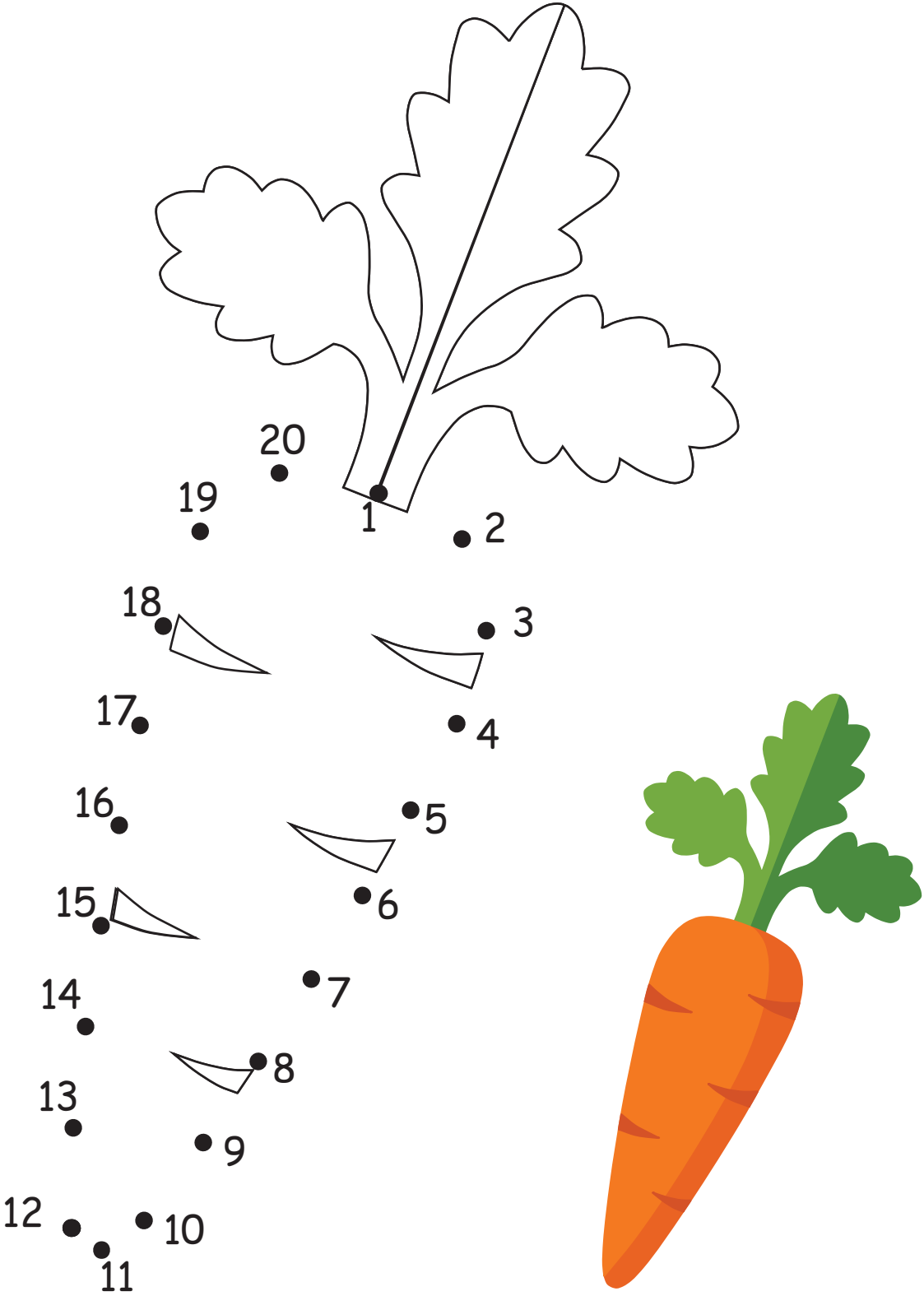

Dot to Dot

A dot-to-dot puzzle of a fish. The puzzle is partially completed with solid lines. The remaining parts are indicated by letters A through Z, each with a small black dot next to it. The letters are: A (top left), B and C (top middle), D, E, F (top right), G and H (far top right), I (middle right), J, K, L (far right), M (middle right), N (middle right), O (middle right), P (bottom middle), Q (bottom middle), R (bottom middle), S (bottom middle), T (bottom middle), U (bottom middle), V (bottom middle), W (bottom middle), X (bottom middle), Y (bottom middle), Z (bottom middle).

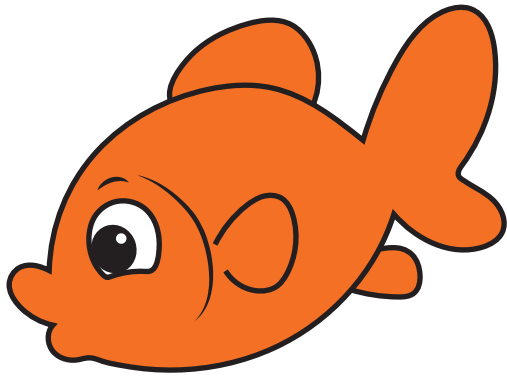

Dot to Dot

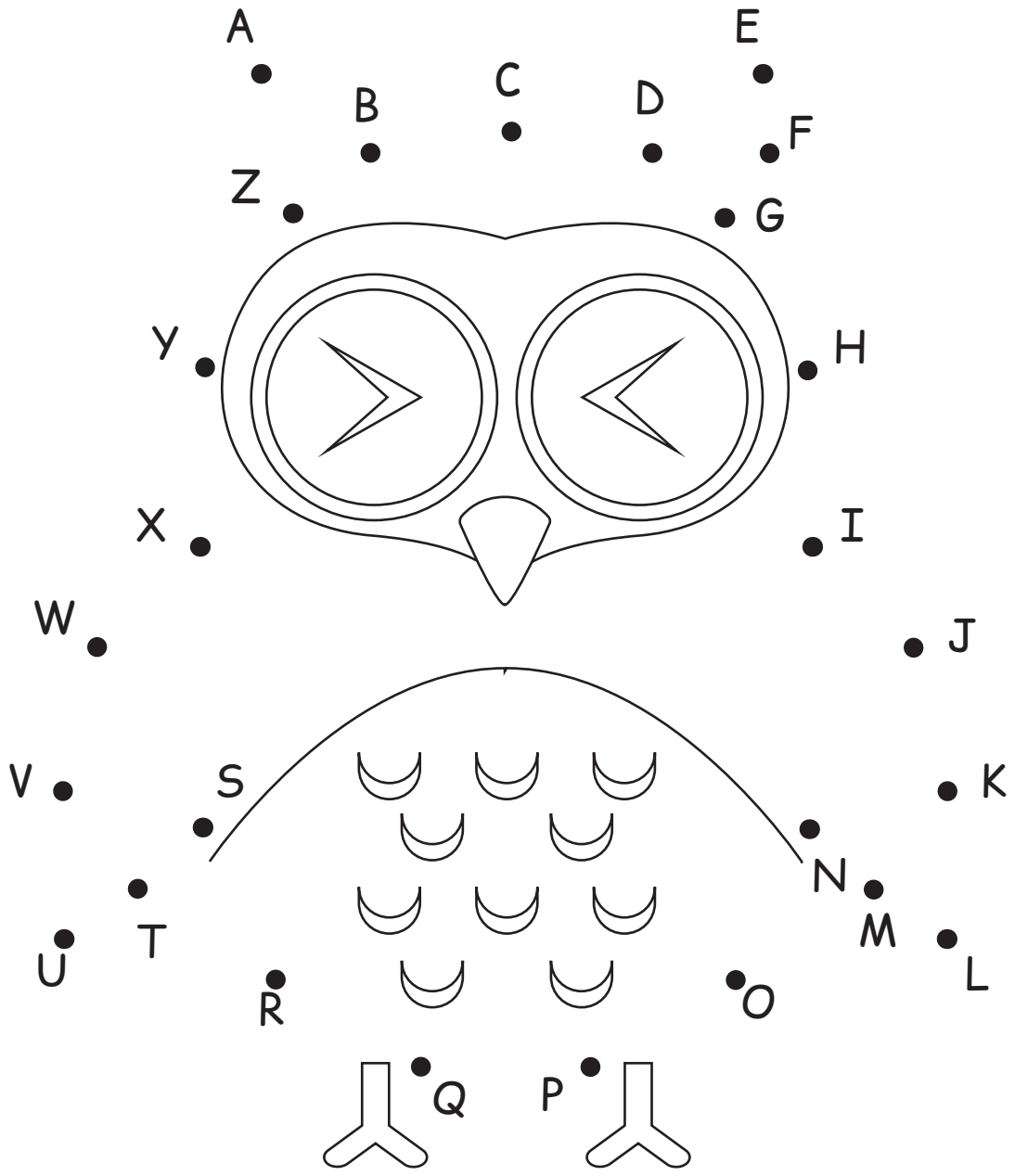

Dot to Dot

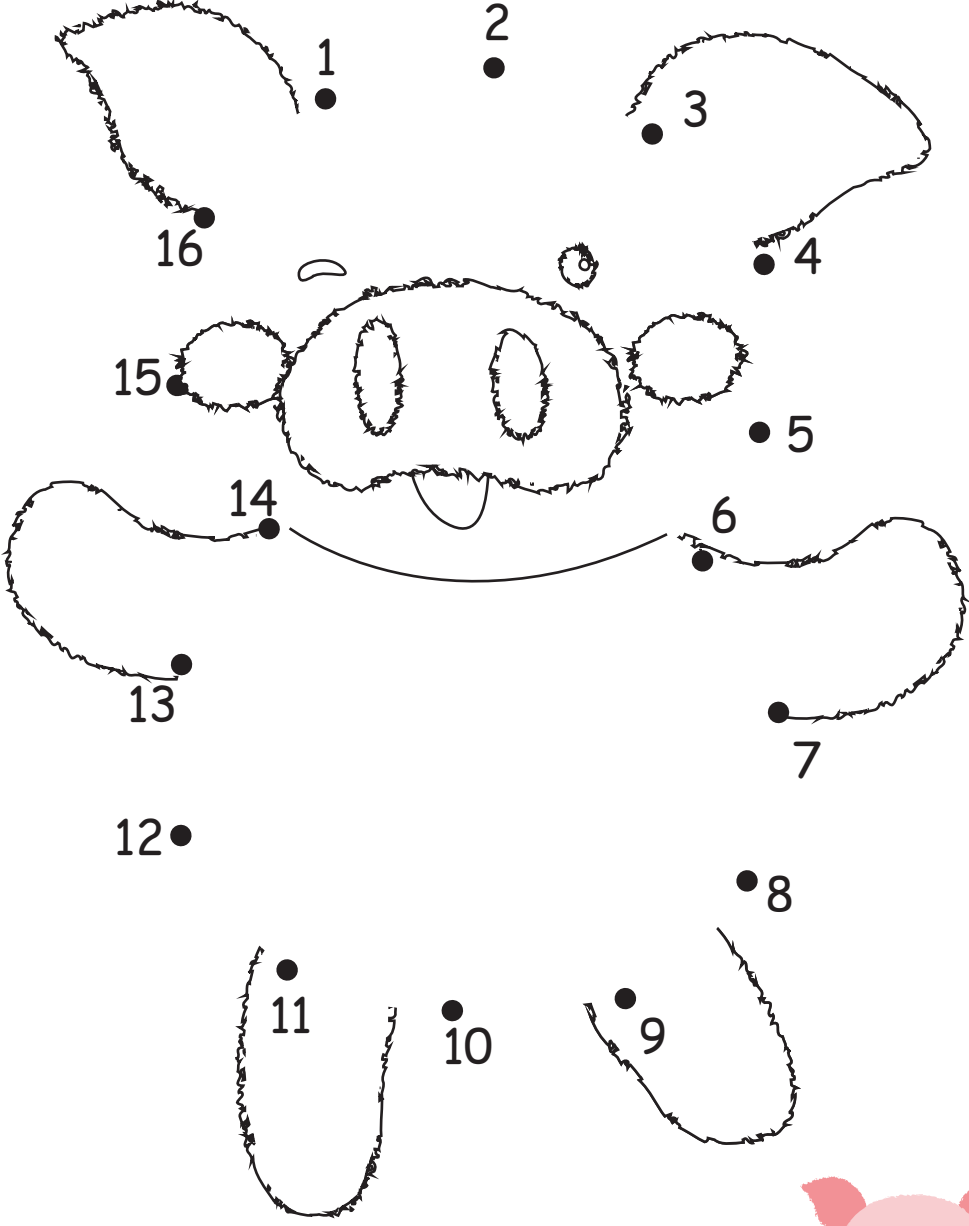

Dot to Dot

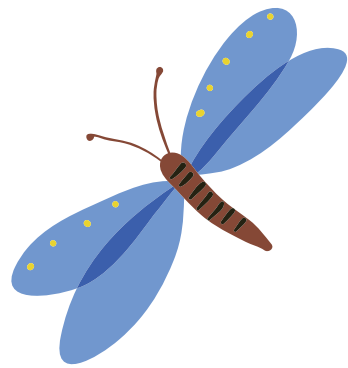
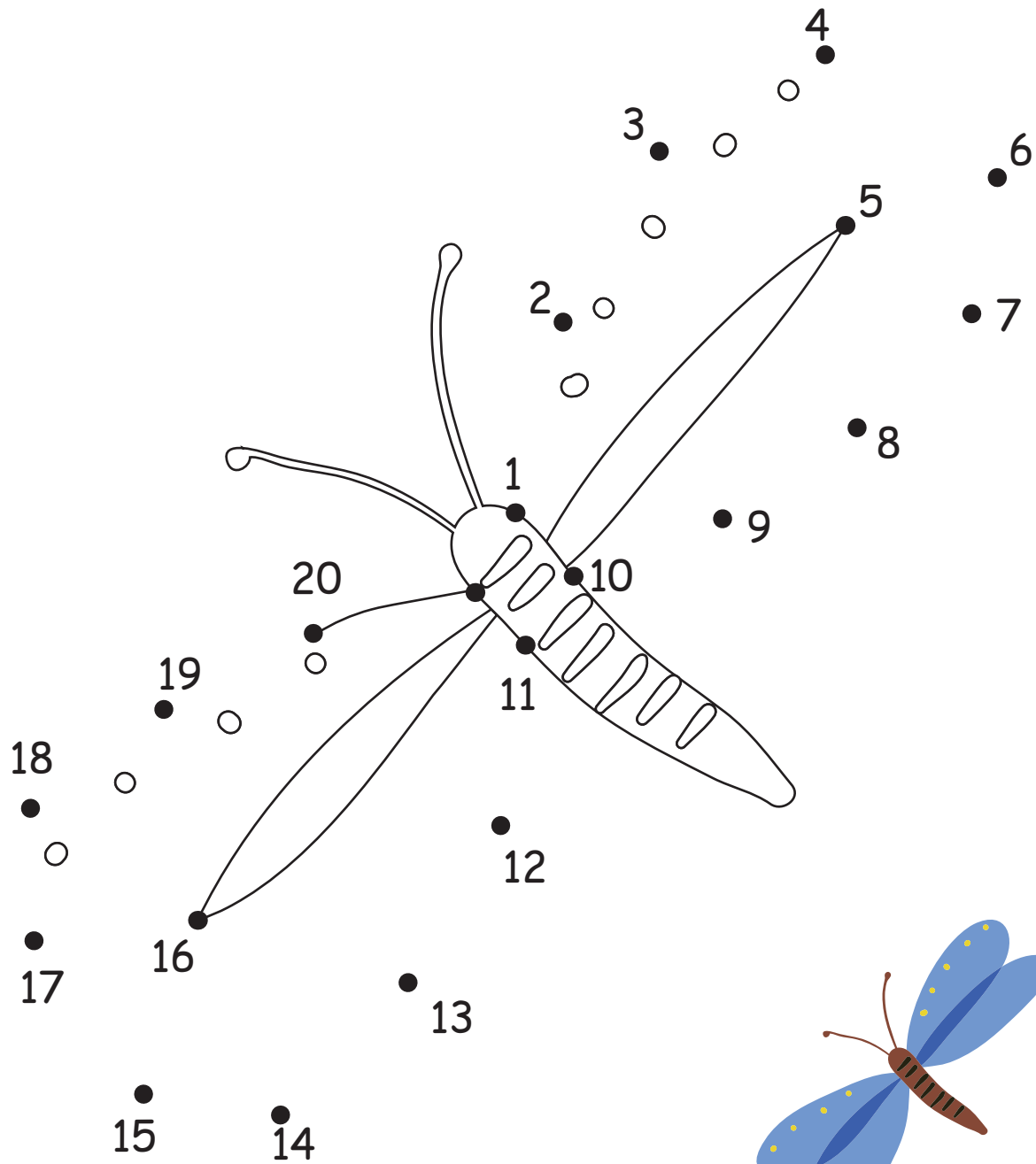

Dot to Dot

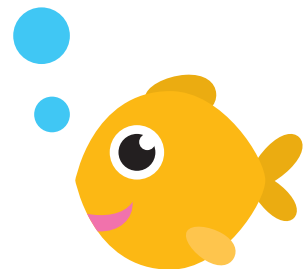
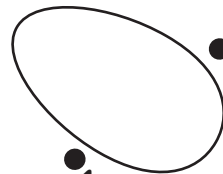
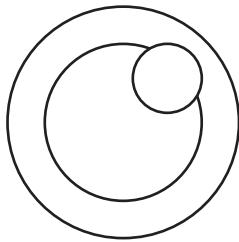
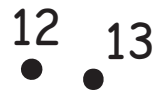
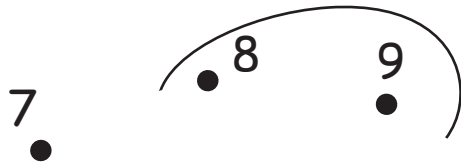
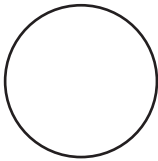
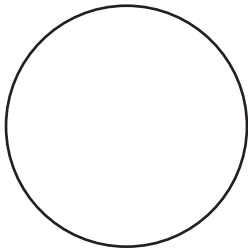

Dot to Dot

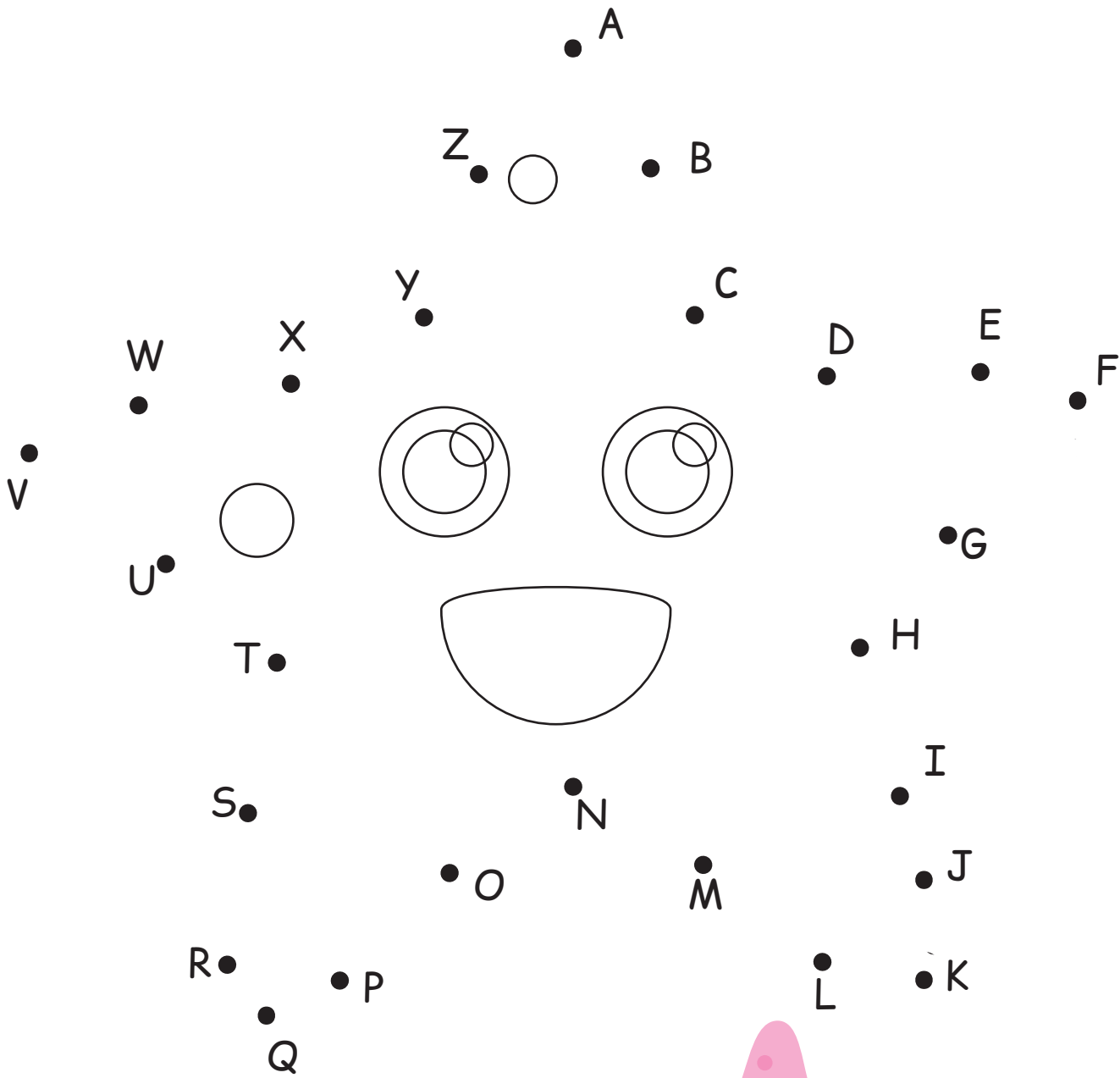

Dot to Dot

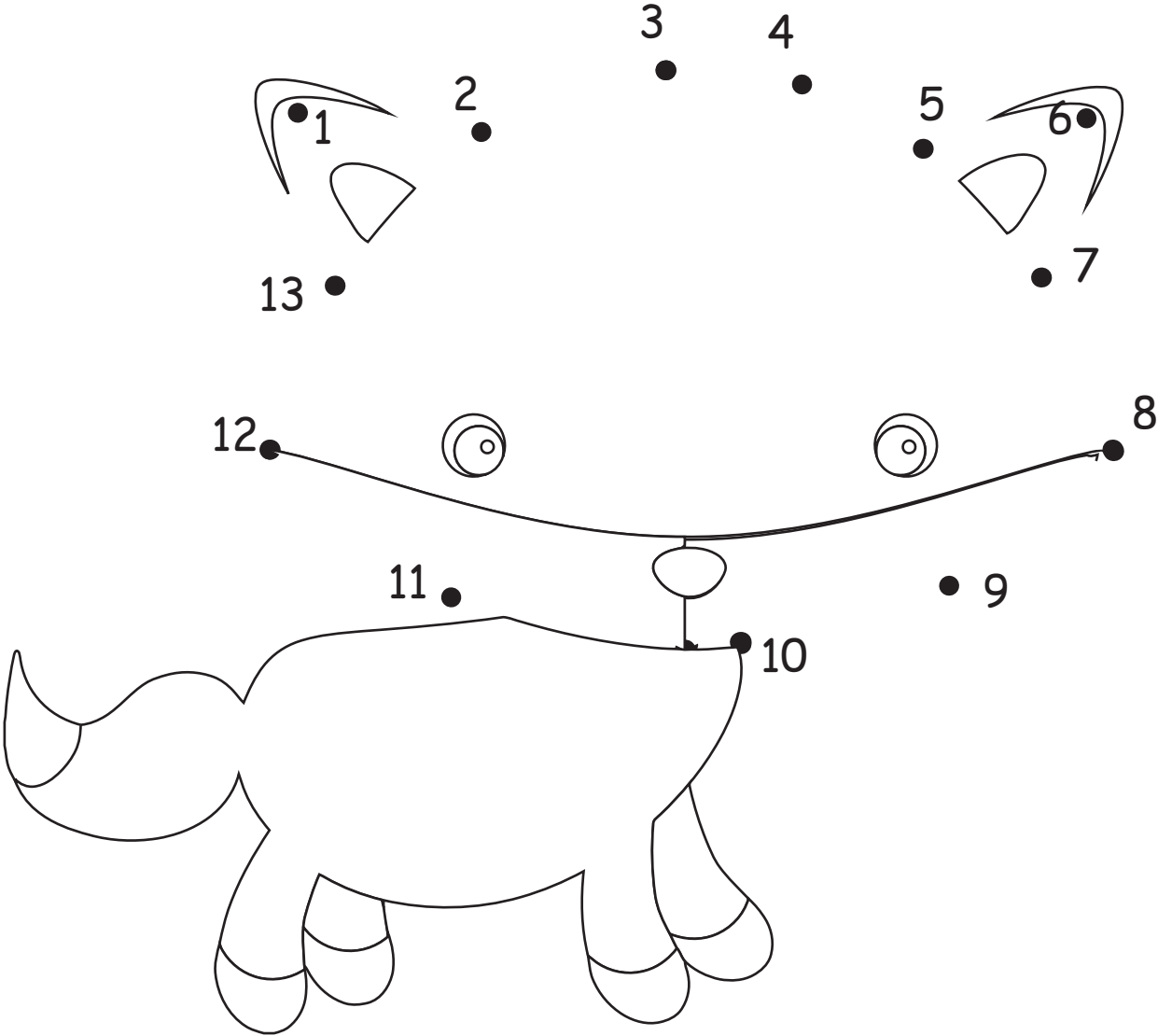

Dot to Dot

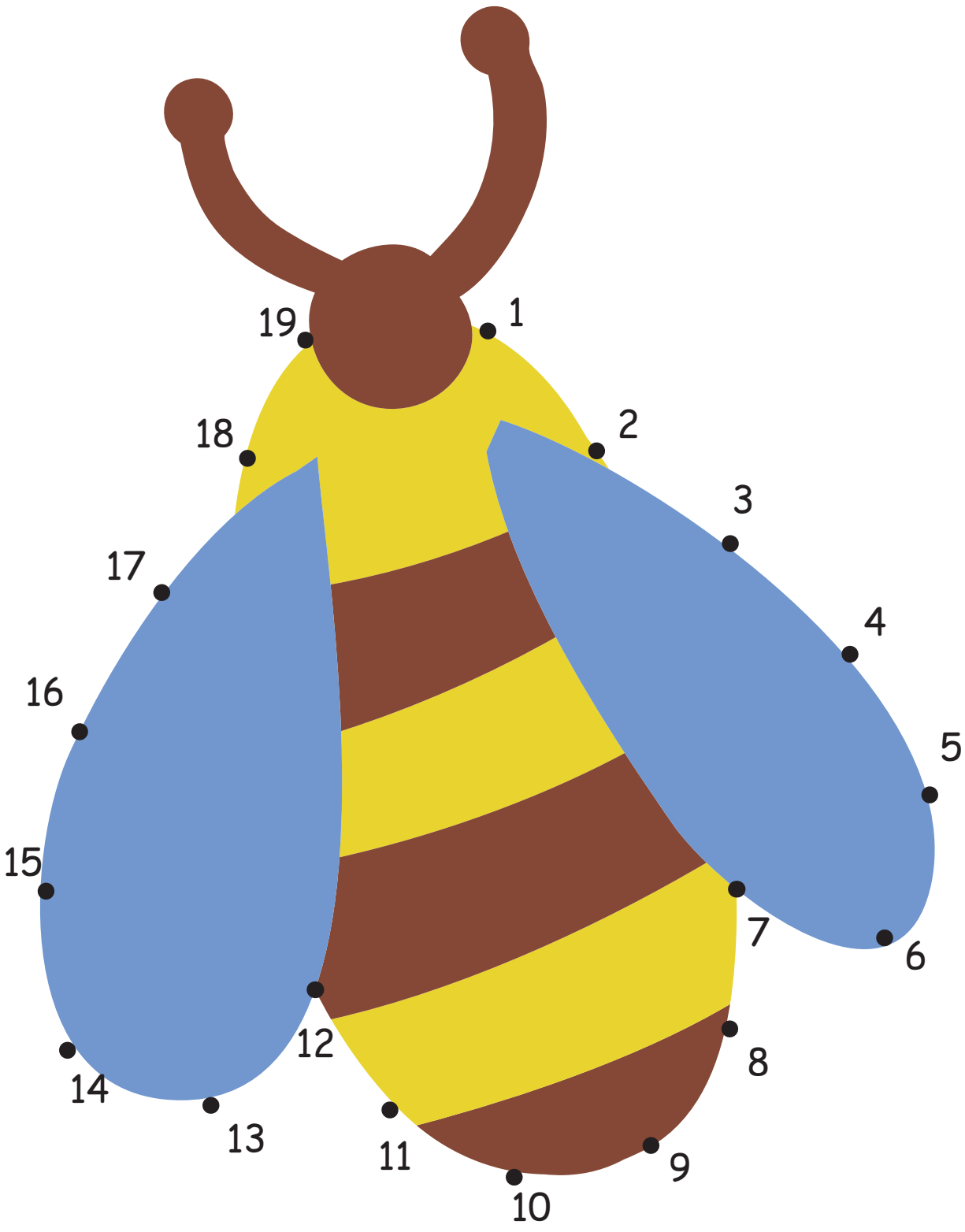

Dot to Dot

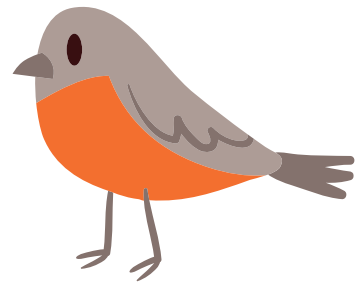
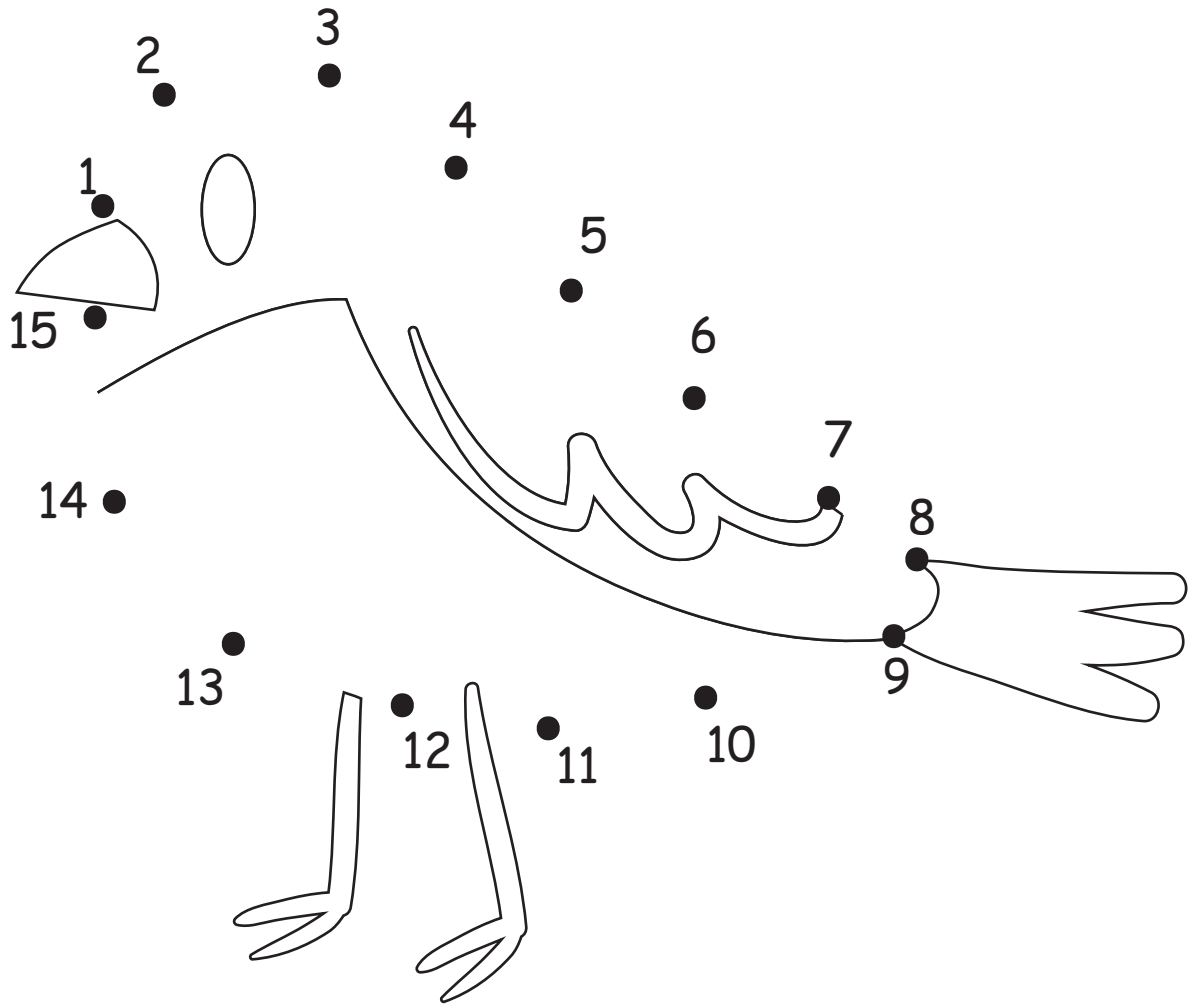

Dot to Dot

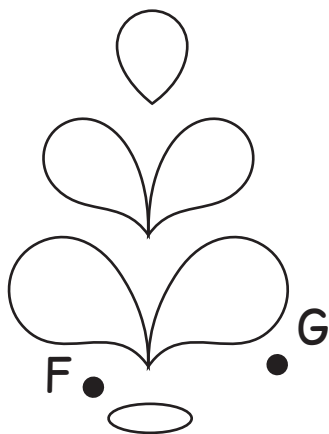

E

I

D

O P Q R S
J N M U T

C

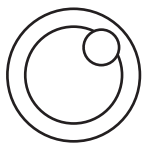

K L



V

B

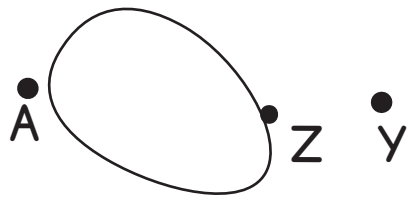

W

X

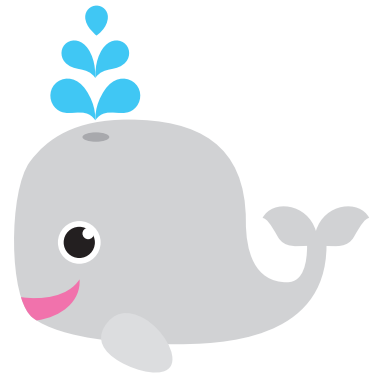

Dot to Dot

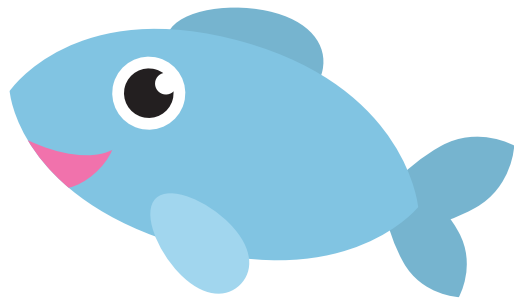
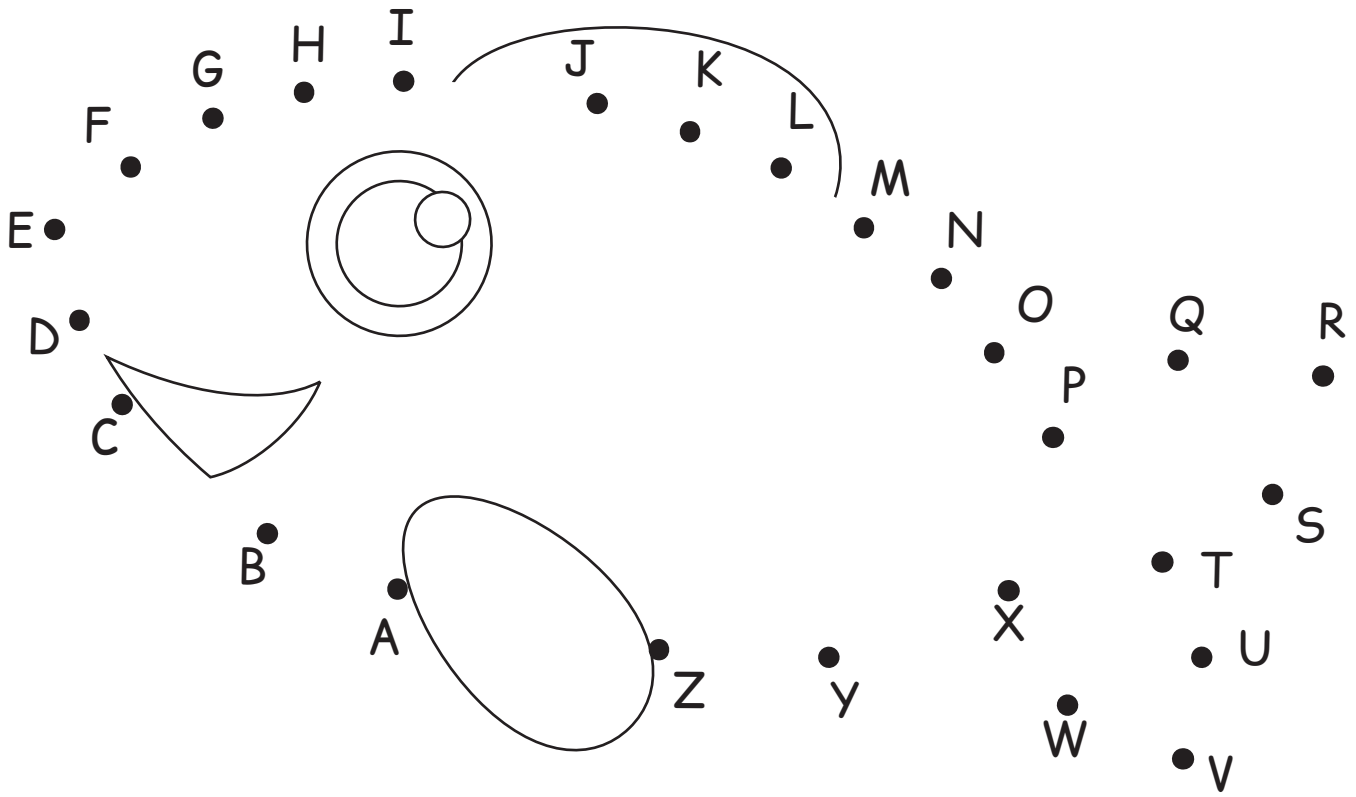

Dot to Dot

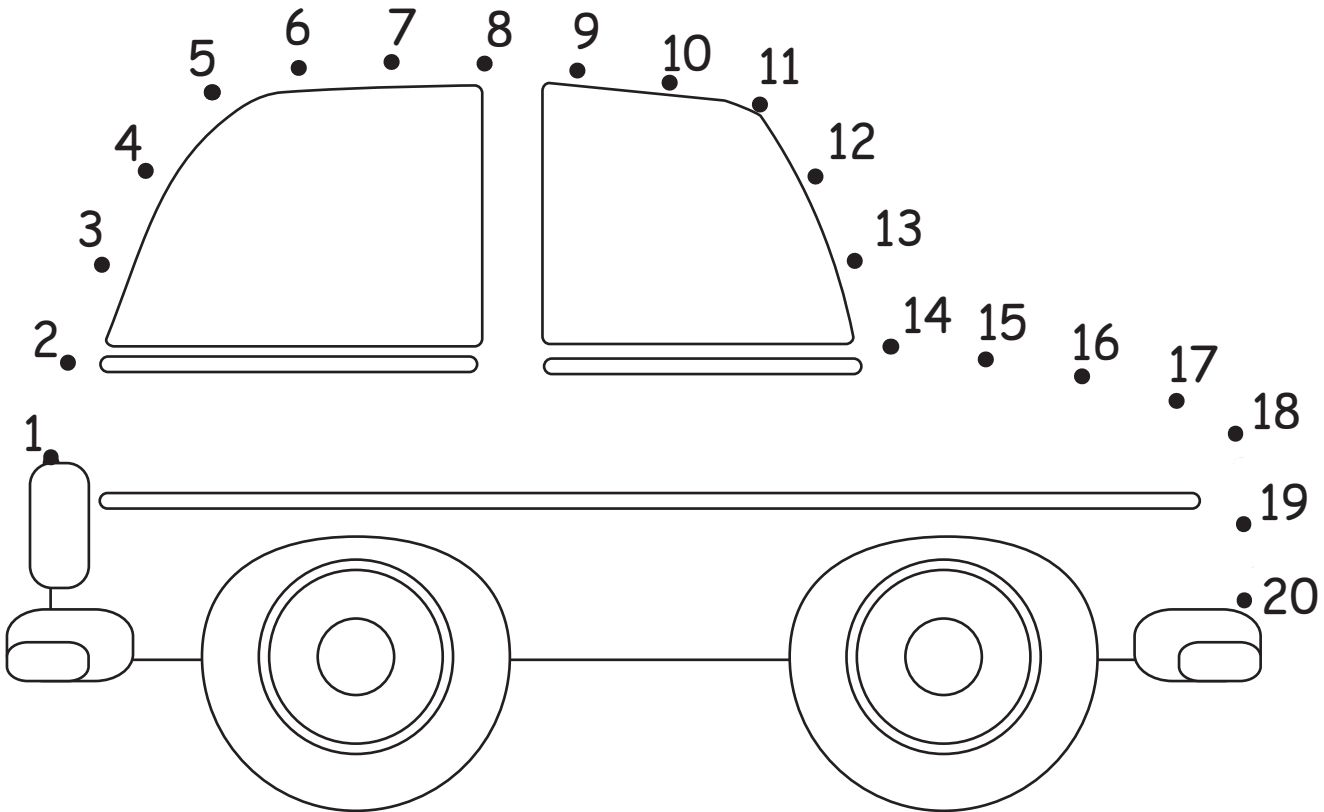

Dot to Dot

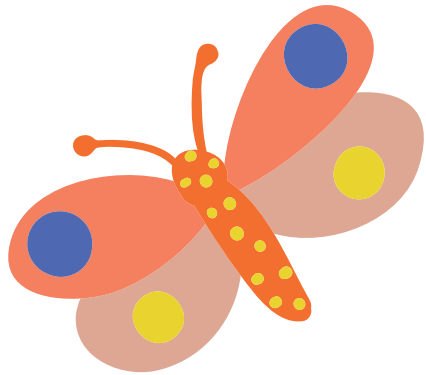
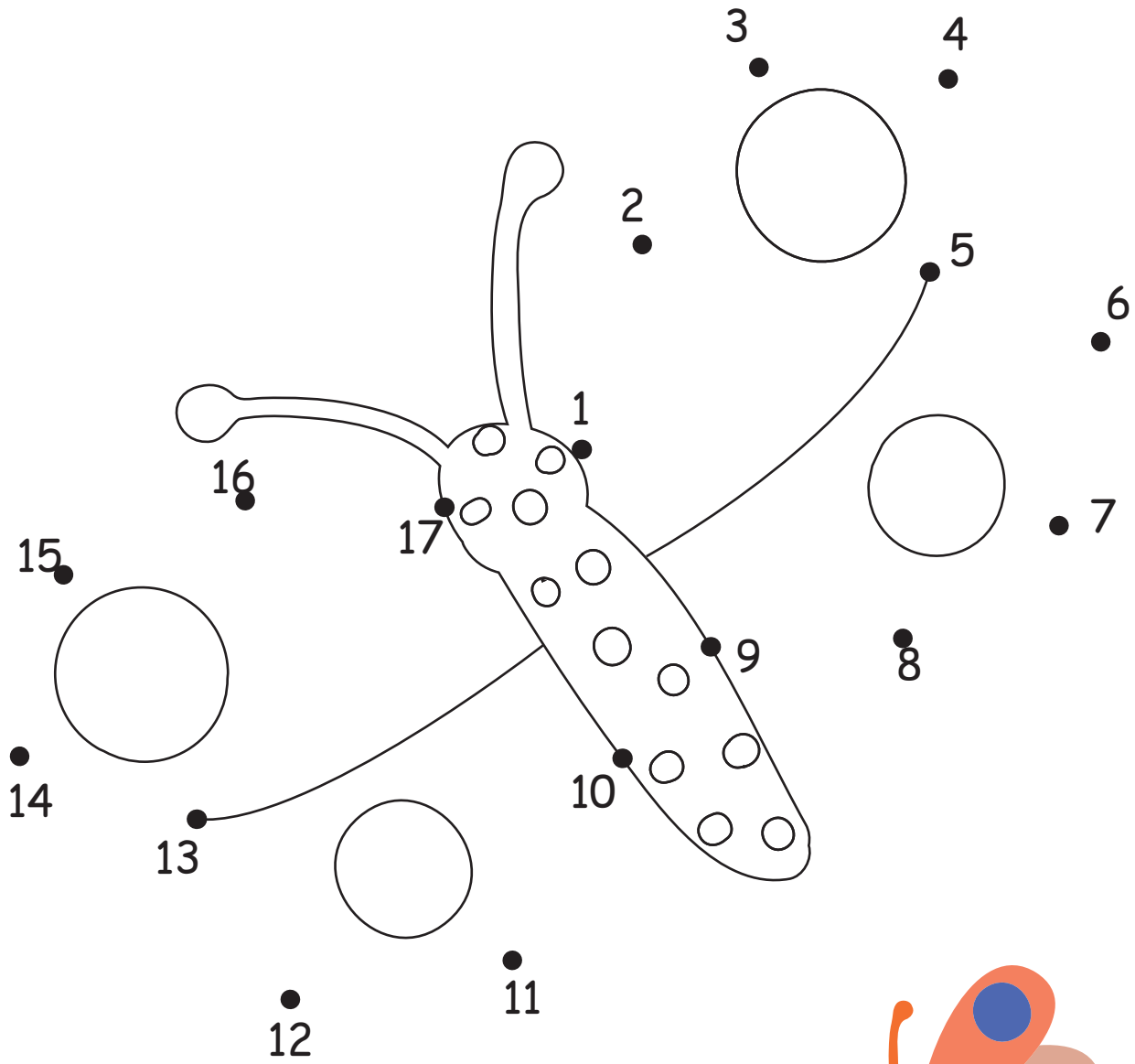

Dot to Dot

